

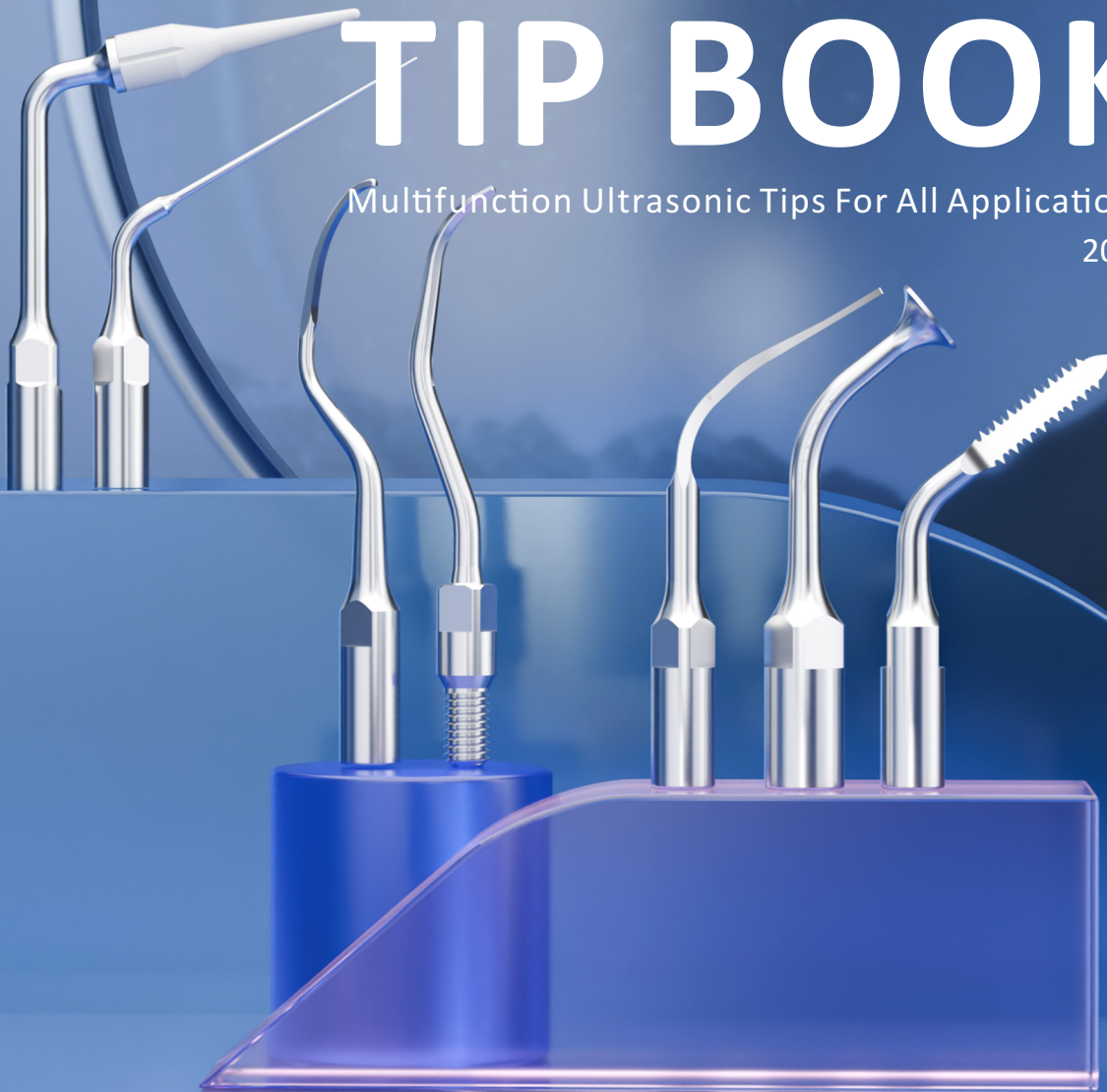

TIP BOOK

Multifunction Ultrasonic Tips For All Applications

2025



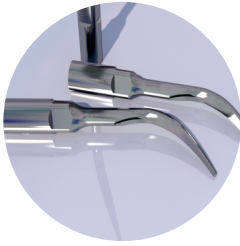

SCALING

Scaling is precise work. Proper instrument selection is essential to achieving complete periodontal cleaning. Our wide variety of tips give you the freedom to choose the exact instrument for the situation.

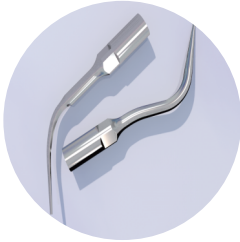

PERIODONTICS

Perio tips are thin and designed for root planing and maintenance to provide the best access to furcation and curved roots.

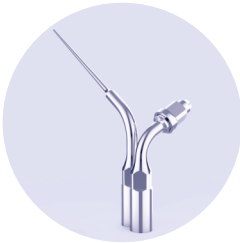

ENDODONTICS

Endodontic tips can be used in many areas in endodontics. They are excellent for the removal of posts, removing dentin in pulp chambers, finding and widening orifices, preparing canals, removing broken instruments and cleaning prepared canals.



CAVITY PREPARATION

These tips are diamond coated and can be used to prepare a cavity in the tooth before carrying out further dental work.



SURGERY TIPS

Surgery tips are designed for a wide range of bone surgery applications, including sinus lifting and implantation procedures.



Principle of Operation.

For piezo style tips, including all Xpedent tips except those to use with NSK® and Kavo Soniflex® compatible air scalers, power is generated by piezoelectric crystals. For airscalers power is generated by compressed air. This creates a sinusoidal motion with the greatest power (amplitude) at the end of the tip followed by a weaker area, then a stronger area in accordance with a sine wave. The effect of the tip is therefore very dependent upon the part of the tip in contact with the tooth. Contact with the side of the tip in the second strong power band, 2-3 mm from the end, creates the most effective action.







The ideal power setting will depend on the tip used and the condition of the area to be treated. Endo and Perio work requires longer and thinner tips than scaling, so lower powers are appropriate. Always start with a low power and increase gradually to maximise effectiveness and minimise patient discomfort.

Orientation and Application.

To create a combination of patient comfort and efficient scaling it is important to use the side of the tip at the second power band and at a very shallow angle to the tooth. Too great an angle will bring the point of the tip in contact with the tooth and lead to patient discomfort.

Unlike hand scaling, ultrasonic scaling requires only a very gentle touch to the tooth surface; the ultrasonics provide all the power so the dental practitioner only needs to guide the tip very gently around the area to be treated. The removal of hard deposits can be expedited by applying the end of the tip where the vibrations are strongest; this will cause calculus to break away from the tooth. Once this is done, resume gentle motions. Too much force, or over-use of the tip end, will cause discomfort.

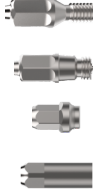
CONTENT

Generic tips		6
Xpedent tips (suitable for use with EMS® scaler machines). The Xpedent brand belongs to a third party which has no connection with the original equipment manufacturer or its representatives.		12
Xpedent tips (suitable for use with SATELEC® scaler machines). The Xpedent brand belongs to a third party which has no connection with the original equipment manufacturer or its representatives.		16
Xpedent tips (suitable for use with NSK® scaler machines). The Xpedent brand belongs to a third party which has no connection with the original equipment manufacturer or its representatives.		21
Xpedent tips (suitable for use with SIRONA® scaler machines). The Xpedent brand belongs to a third party which has no connection with the original equipment manufacturer or its representatives.		24
Xpedent tips (suitable for use with KAVO® scaler machines). The Xpedent brand belongs to a third party which has no connection with the original equipment manufacturer or its representatives.		26
Xpedent tips (suitable for use with AMDENT® scaler machines). The Xpedent brand belongs to a third party which has no connection with the original equipment manufacturer or its representatives.		32
Xpedent tips (suitable for use with MECTRON® scaler machines). The Xpedent brand belongs to a third party which has no connection with the original equipment manufacturer or its representatives.		34

CONTENT

<p>Xpedent tips (suitable for use with SATELEC® surgery machines). The Xpedent brand belongs to a third party which has no connection with the original equipment manufacturer or its representatives.</p>		41
<p>Xpedent tips (suitable for use with EMS® surgery machines). The Xpedent brand belongs to a third party which has no connection with the original equipment manufacturer or its representatives.</p>		41
Xpedent torque wrenches & wrenches		45
U-Files		46
Thread identification		46
Xpedent scaler handpieces		47
Autoclavable tip holders		47
Xpedent built-in scaler machines		48
Tip wallets		49

SIRONA® is a registered trademark of Sirona Dental Systems GmbH
EMS® is a registered trademark of Electro Medical Systems SA
SATELEC® is a registered trademark of ACTEON Group
Mectron® is a registered trademark of Mectron s.p.a.
Amdent® is a registered trademark of LM Instruments Oy
Kavo® is a registered trademark of KAVO Dental Corporation
NSK® is a registered trademark of Nakanishi INC. Corporation

 diamond coated
 irrigation

- Xpedent tips suitable for use with EMS® scaling devices
- Xpedent tips suitable for use with SIRONA® scaling devices
- Xpedent tips suitable for use with SATELEC® scaling devices
- Xpedent tips suitable for use with NSK® scaling devices
- Xpedent tips suitable for use with MECTRON® scaling devices

SCALING

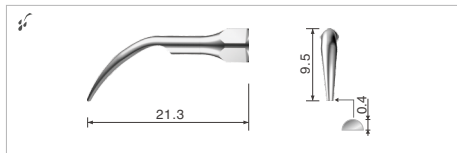

Used to remove light and medium supragingival calculus and bacterial plaque.

- G1
- GS1
- GN1
- GD1
- GM1

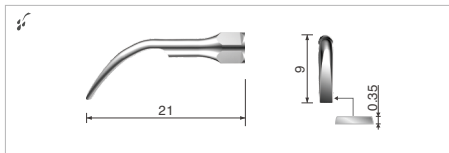

Flat edge is used to remove heavy supragingival calculus.

- G2
- GS2
- GN2
- GD2

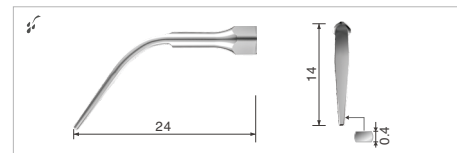

Used to remove calculus and bacterial plaque from supragingival interdental areas.

- G3
- GS3
- GN3
- GD3
- GM3

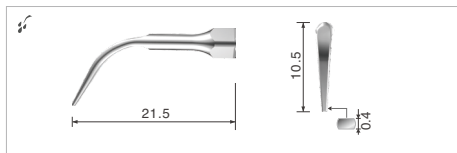

Used to remove all supragingival calculus and bacterial plaque.

- G4
- GS4
- GN4
- GD4
- GM4

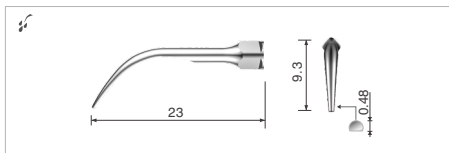

Used to remove all supragingival calculus and bacterial plaque.

- G5
- GS5
- GN5
- GD5
- GM5

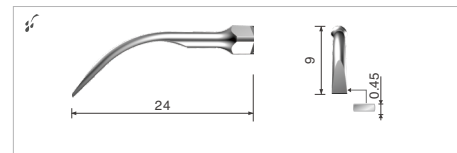

Used to remove heavy supragingival calculus.

- G6
- GN6
- GD6
- GM6

PERIO

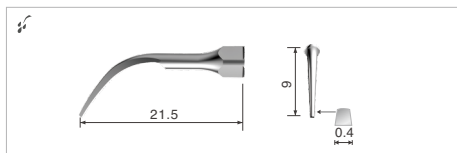

Used to remove subgingival calculus.

- P1
- PS1
- PN1
- PD1
- PM1

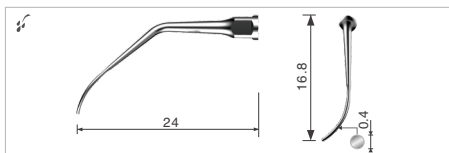

Curved to the left, for treating furcations, interdental calculus and very narrow spaces.

- P2L
- PN2L
- PD2L

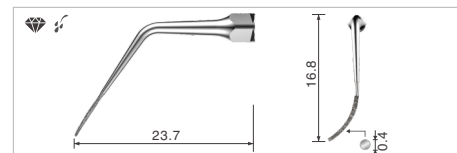

Curved to the left and diamond coated, for treating furcations, interdental calculus and very narrow spaces.

- P2LD
- PD2LD

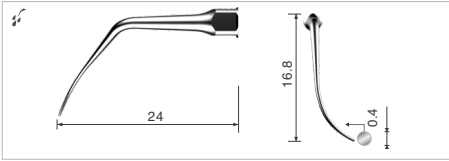

Curved to the right, for treating furcations, interdental calculus and very narrow spaces.

P2R

PN2R

PD2R

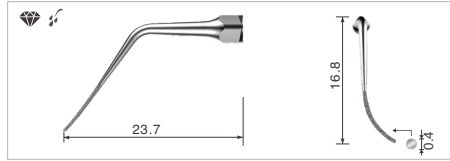

Curved to the right and diamond coated, for treating furcations, interdental calculus and very narrow spaces.

P2RD

PD2RD

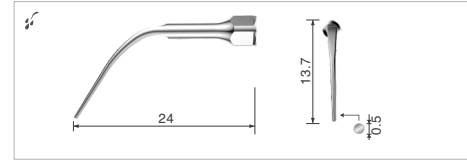

Used to remove subgingival calculus.

P3

PS3

PN3

PD3

PM3

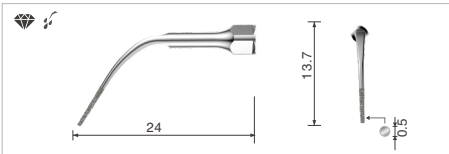

Diamond coated, used to smooth the surface of root during periodontal flap surgery.

P3D

PS3D

PN3D

PD3D

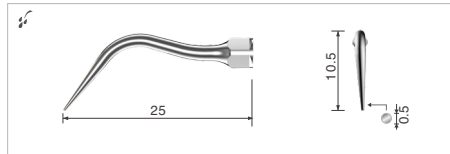

Used to remove subgingival calculus.

P4

PS4

PN4

PD4

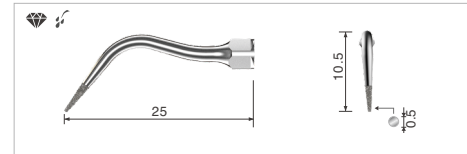

Diamond coated, a powerful tool for the removal of calcification, this tip can be used for widening calcified roots in the coronal third.

P4D

PN4D

PD4D

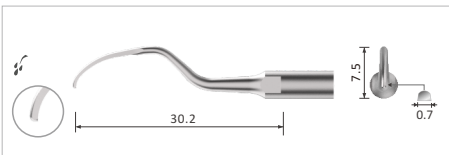

Anterior Periodontics. Enables treatment of the incisor-canine block. The guide edge is oriented parallel to the pocket. Enables work in the periodontal pocket without injury to the ligament.

eH3 (P5)

sH3

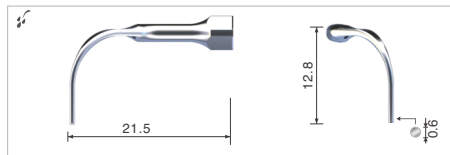

Curved to the left, used to remove subgingival calculus.

P6L

PD6L

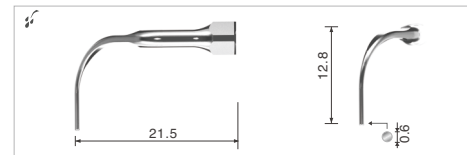

Curved to the right, used to remove subgingival calculus.

P6R

PD6R

ENDO



120° angle holder for use with Xpedit U files with a shank diameter of 0.57mm, this tip is usually used for anterior root canal cleaning.

- E1
- ES1
- EN1
- ED1

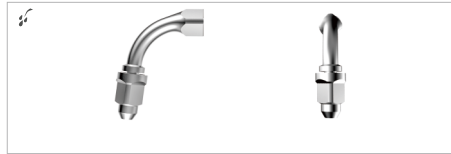

95° angle holder for use with Xpedit U files with a shank diameter of 0.57mm, this tip is usually used for anterior root canal cleaning.

- E2
- ES2
- EN2
- ED2

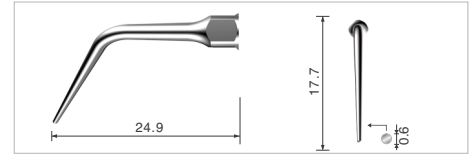

With cooling spray disabled, this tip is used for lateral thermal condensation of gutta percha.

- E3
- ES3
- EN3
- ED3

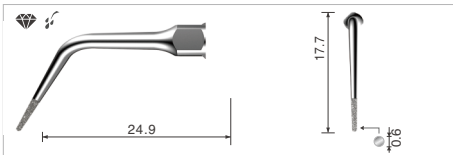

Diamond coated, used to remove calcification and bad filling material from pulp cavity and overhang pulp chamber.

- E3D
- ES3D
- EN3D
- ED3D

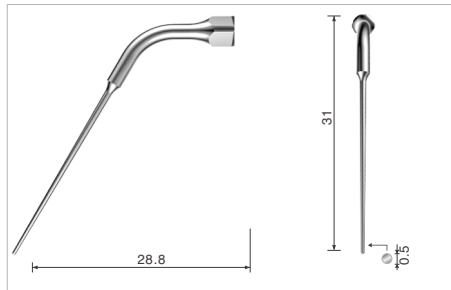

Quickly removes obstructions and broken instruments in the mid and upper thirds of large and straight canals.

- E4
- ES4
- EN4
- ED4

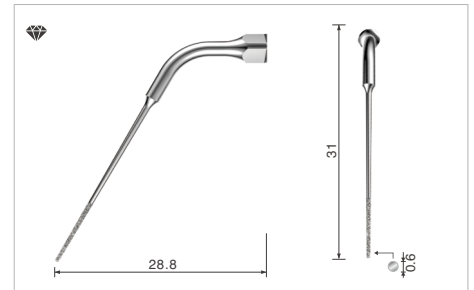

Diamond coated, for retreatments or extremely hard materials.

- E4D
- ES4D
- EN4D
- ED4D

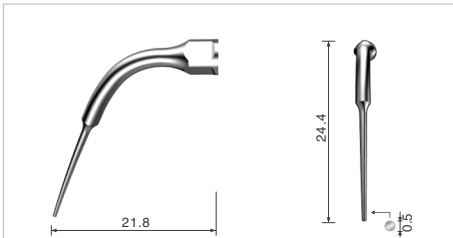

Useful for quickly eliminating calculus and temporary cements.

- E5
- ES5
- EN5
- ED5

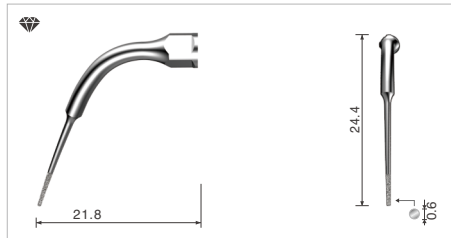

Diamond Coated, for enhanced cutting and abrasion. Especially useful for removing very hard materials on the canal wall.

- E5D
- ES5D
- EN5D
- ED5D

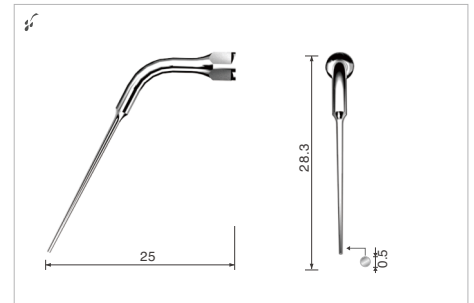

Quickly removes obstructions and broken instruments in the mid and upper thirds of large and straight canals.

- E14
- EN14
- ED14

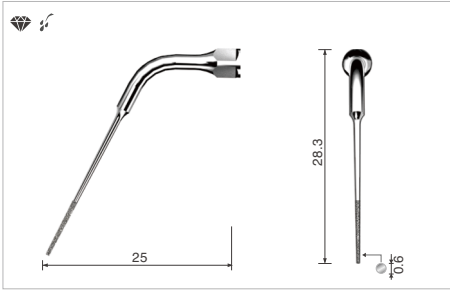

Diamond coated for retreatments or extremely hard materials.

E14D

EN14D

ED14D

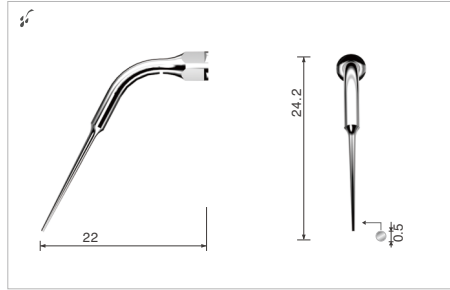

Useful for quickly eliminating calculus and temporary cements.

E15

EN15

ED15

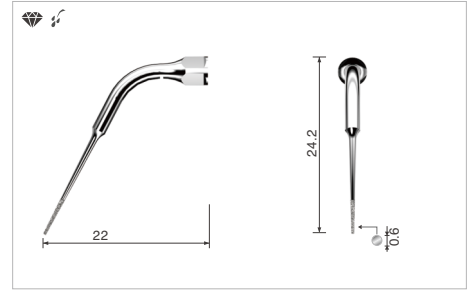

Diamond coated, for enhanced cutting and abrasion. Especially useful for removing very hard materials on the canal wall.

E15D

EN15D

ED15D

RETRO

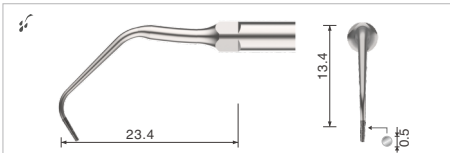

Used for gentle treatment of the root canal of anterior teeth.

E10

EN10

ED10

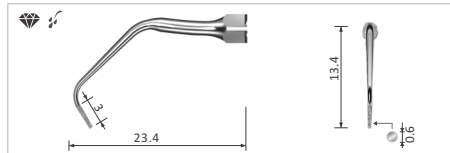

Diamond coated, used for efficient apical polishing of anterior teeth.

E10D

EN10D

ED10D

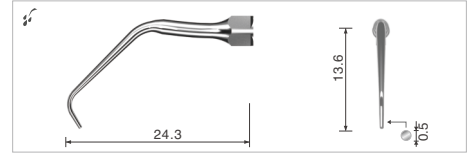

Used for gentle treatment in the root canal of anterior teeth.

E11

EN11

ED11

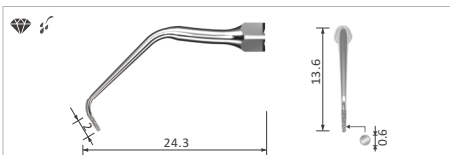

Diamond coated, with enhanced cutting and abrasive power; especially useful for removing very hard materials on the canal wall and lateral cutting.

E11D

EN11D

ED11D

CROWN REMOVAL

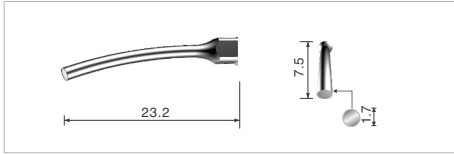

Used to remove bridges, crowns and posts by fracturing the cement.

G7

G57

GN7

GD7

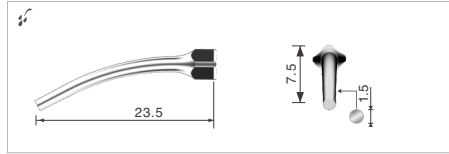

Used to remove bridges, crowns and posts by fracturing the cement.

G8

CAVITY PREPARATION

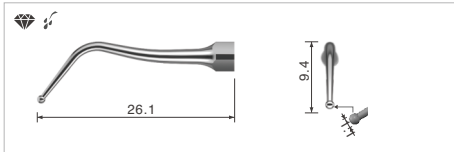

Ball diamond tip, for preparation of occlusal surfaces and cervical ridges.

SB1

SBS1

SBN1

SBD1

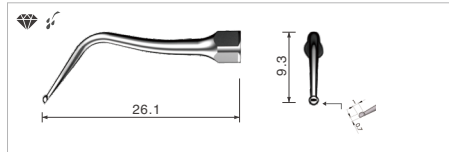

Semi-spherical diamond tip, for finishing cervical interproximal areas without causing lesions to adjacent teeth.

SB2

SBS2

SBN2

SBD2

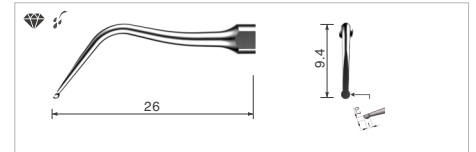

Semi-spherical diamond tip, for finishing cervical interproximal areas without causing lesions to adjacent teeth.

SB3

SBS3

SBN3

SBD3

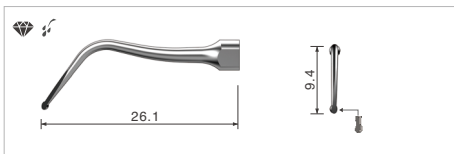

Semi-spherical diamond tip set 45° to the left. Allows the dentist to remove carious areas of a tooth without damaging the adjacent teeth.

SBL

SBSL

SBNL

SBDL

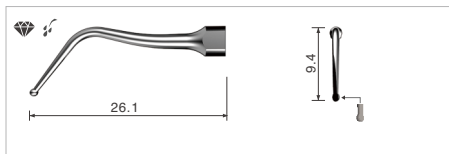

Semi-spherical diamond tip set 45° to the right. Allows the dentist to remove carious areas of a tooth without damaging the adjacent teeth.

SBR

SBSR

SBNR

SBDR

FG-BUR HOLDER



FG-bur holder used to expand the root canal and grind teeth.

E8

EN8

ED8

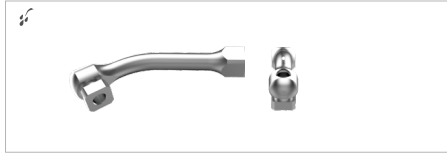

FG-bur holder used to expand the root canal and grind teeth.

E9

EN9

ED9

IMPLANT CLEANING

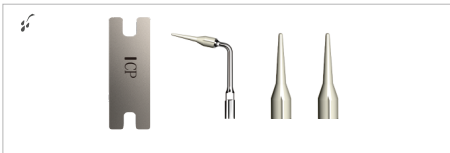

Implant Cleaning. The ICP tip is used for sub- and supragingival cleaning of implants and restorations. The replaceable peek makes the action safe and gentle. The set contains 1 ICP, 1 ICP wrench and 2 spare peeks. Replacement

eICP SET

srICP SET

nICP SET

sICP SET



Replacement. ICPpeeks are autoclavable and reusable. Replacing the ICPpeek is simple using the wrench included in ICP SET.

ICPpeek

ICPpeek

ICPpeek

ICPpeek



Xpedent tips (suitable for use with EMS[®] scaler machines).
The Xpedent brand belongs to a third party which has no connection with the original equipment manufacturer or its representatives.

SCALING

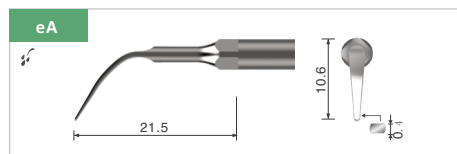

Universal. Accurate removal of solid supragingival calculus in all quadrants.

PERIO

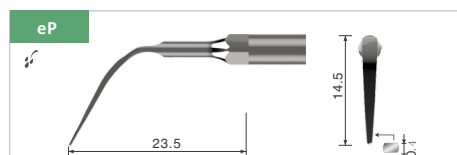

Perio. The eP instrument is well suited for the precise removal of stubborn subgingival and supragingival calculus and concretions in all quadrants.

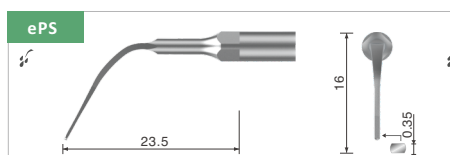

PerioSlim. The fast and minimally-invasive ePS instrument is ideal for calculus removal in deep periodontal pockets in all quadrants.

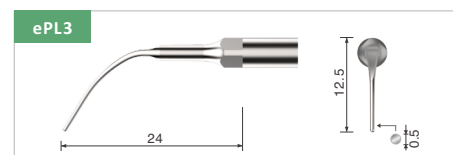

Perio Cleaning. For cleaning and disinfecting periodontal pockets, it is especially suitable for follow-up and recall visits for periodontal maintenance patients.

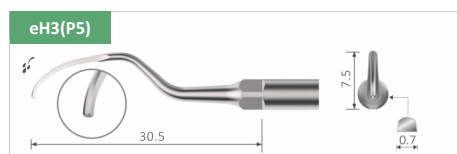

Anterior Periodontics. Enables treatment of the incisor-canine block. The guide edge is oriented parallel to the pocket. Enables work in the periodontal pocket without injury to the ligament.

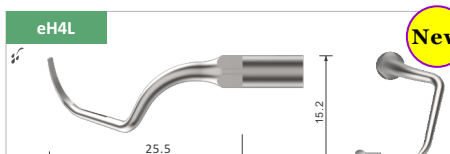

Premolar and Molar. Left-curve. First instrument for treating all the surfaces and the furcations.
Maxillary. Buccal and distal surfaces of sector 2, pivots at 13, then the buccal and mesial surfaces of sector 1.
Mandibular. Buccal and distal surfaces of sector 4, pivots at 43, then lingual and mesial surfaces of sector 3.

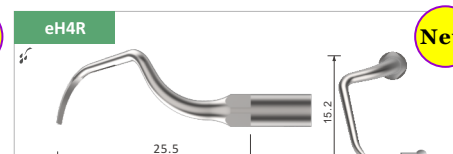

Premolar and Molar. Right-curve. Second instrument, use after sH4L.
Maxillary. Palatine and mesial surfaces of sector 2, pivots at 13, then buccal and distal surfaces of sector 1.
Mandibular. Lingual and mesial surfaces of sector 4, pivots at 43, then buccal and distal surfaces of sector 3.

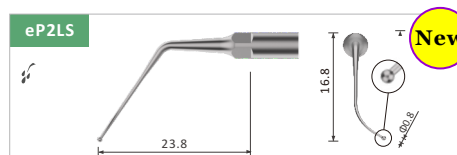

Perio. Left curved instrument with a small ball > 0.8 mm diameter on the instrument tips for periodontal debridement of furcations and concavities

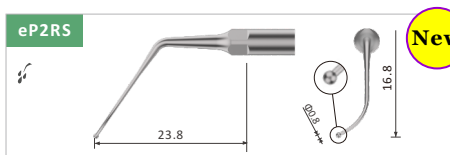

Perio. Right curved instrument with a small ball > 0.8 mm diameter on the instrument tips for periodontal debridement of furcations and concavities

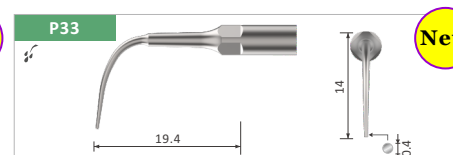

Perio. Used to remove dental calculus deep in the periodontal pocket and clean the periodontal pocket.

ENDO

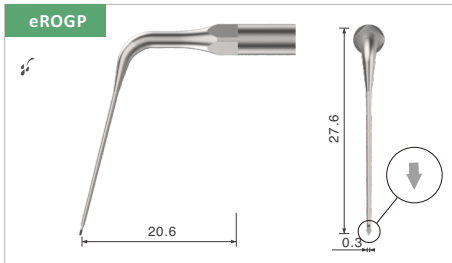

Access Long Canals. The ROGP tip is used to access areas not reached by other tips. Particularly effective for retreatments, especially in long oval canals, where most other tips would not fit. Excellent for Gutta-Percha removal.

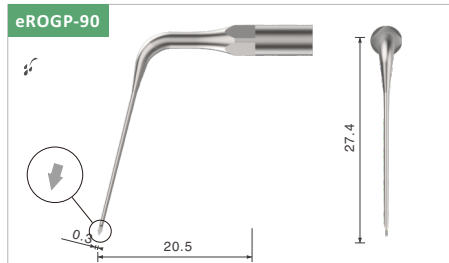

Access Long Canals - 90°. The ROGP tip is used to access areas not reached by other tips. Particularly effective for retreatments, especially in long oval canals, where most other tips would not fit. Excellent for Gutta-Percha removal.

CONDENSATION



Condensation. For cementing ceramic inlays, onlays and veneers. The eC20 SET contains 1 eC20 and 2 spare peeks.



Replacement. C20peeks are autoclavable and reusable.

IMPLANT CLEANING



Implant Cleaning. The ICP tip is used for sub- and supragingival cleaning of implants and restorations. The replaceable peek makes the action safe and gentle. The set contains 1 ICP, 1 ICP wrench and 2 spare peeks.



Replacement. ICPpeeks are autoclavable and reusable. Replacing the ICPpeek is simple using the wrench included in ICP SET.

SETS (TORQUE WRENCH INCL. SCALER TIP)



TW UNI P



Universal
Plastic Torque Wrench



16



Xpedent tips (suitable for use with SATELEC® scaler machines).
The Xpedent brand belongs to a third party which has no connection with the original equipment manufacturer or its representatives.

SCALING

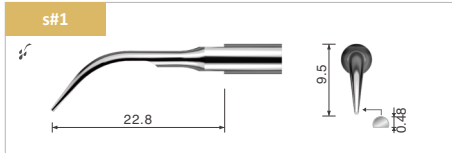

Universal. Simple supragingival scaling and tartar removal without damage to the enamel.

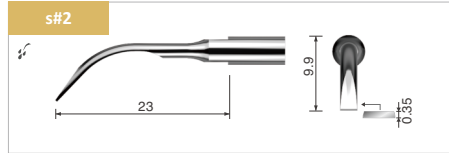

Calculus. Apply the flat part to the tooth to remove major calculus deposits.

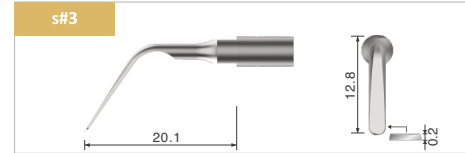

Stain Removal. Rounded leading edge is effective for the removal of marks or stains such as tobacco or tea.

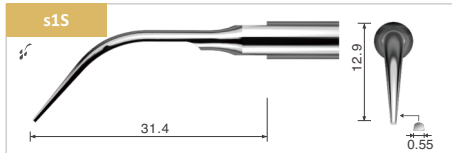

Slim. Supra and subgingival scaling. Particularly effective for interproximal spaces.

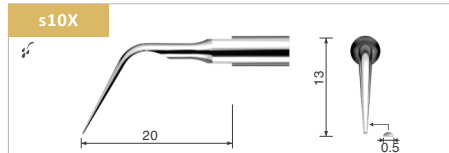

Interproximal. Its flat active part makes it suitable for the interproximal spaces and supragingival scaling. Its anatomical design enables fast and efficient use.

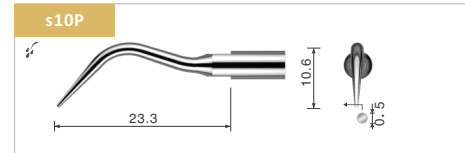

Shallow. Slim round instrument suitable for scaling shallow pockets less than 2-3mm deep.

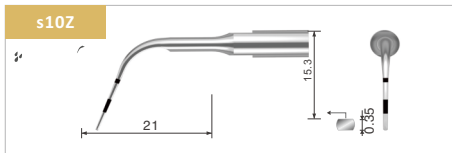

Subgingival. Medium pockets (< 4mm). Removal of biofilm and soft deposits, enables observation of pocket depth using the 3mm scale.

PERIO

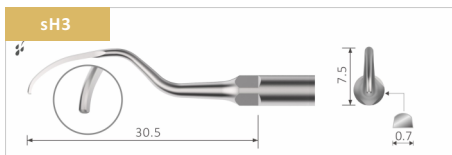

Anterior Periodontics. Enables treatment of the incisor-canine block. The guide edge is oriented parallel to the pocket. Enables work in the periodontal pocket without injury to the ligament.

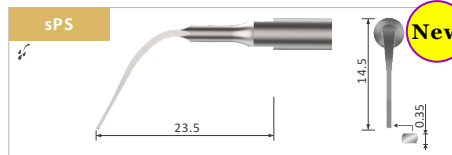

PerioSlim. The fast and minimally-invasive sPS instrument is ideal for calculus removal in deep periodontal pockets in all quadrants.

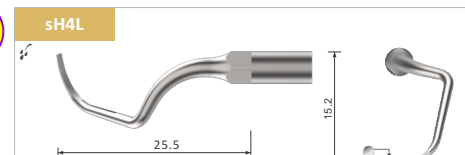

Premolar and Molar. Left-curve. First instrument suitable for treating all the surfaces and the furcations.
Maxillary. Buccal and distal surfaces of sector 2, pivots at 13, then the buccal and mesial surfaces of sector 1.
Mandibular. Buccal and distal surfaces of sector 4, pivots at 43, then lingual and mesial surfaces of sector 3.

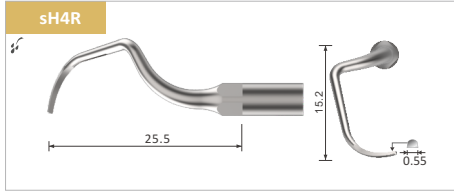

Premolar and Molar. Right-curve. Second instrument, use after sH4L.

Maxillary. Palatine and mesial surfaces of sector 2, pivots at 13, then buccal and distal surfaces of sector 1.

Mandibular. Lingual and mesial surfaces of sector 4, pivots at 43, then buccal and distal surfaces of sector 3.

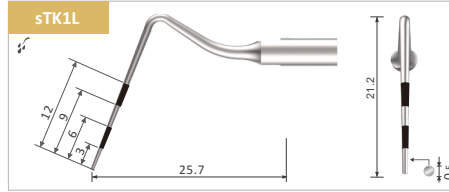

Extended Probe. Ideal for examining and maintenance of medium to deep pockets (> 4mm). A diagnosis aid used during the debridement and irrigation of pockets.

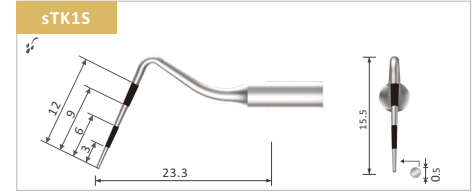

Probe. Recommended for examining shallow and medium pockets (< 4mm) and for the maintenance of simple cases. sTK1S tip is graduated every 3mm.

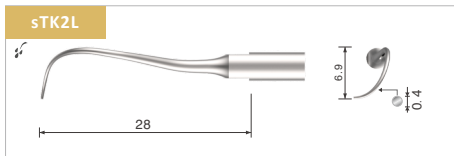

Left-Oriented Maintenance. Recommended for the maintenance of moderate to deep pockets and furcations. Equivalent to the Nabers probe.

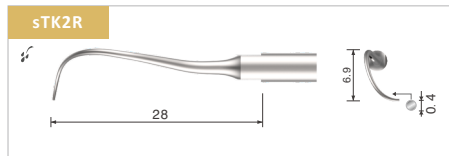

Right-Oriented Maintenance. Recommended for the maintenance of moderate to deep pockets and furcations. Equivalent to the Nabers probe.

ENDO

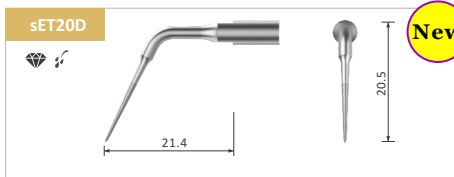

Diamond Coated Retreatment. Used for the removal of hard materials in the 1st coronal third, 30 µm diamonds,

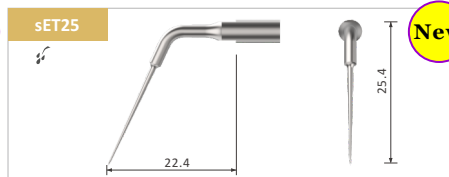

Retreatment. Preferred to use in the middle and apical thirds for retreatment and the extraction of broken instruments, Titanium-alloy, length 20mm, taper 3%.

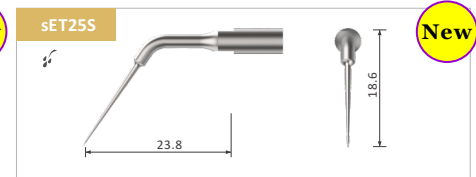

Retreatment Short. Used in coronal third and the isthmuses, Titanium-alloy, length 15mm, taper 4%.

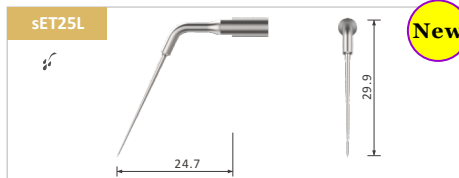

New

Retreatment Long. Used in the apical third and long straight canals for retreatment, Titanium-alloy, length 25mm, taper 3%.

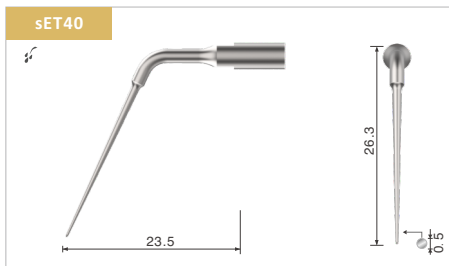

Instrument Removal. Used in the middle third of wide, straight canals, the sET40 is a rapid solution for removal of broken instruments.

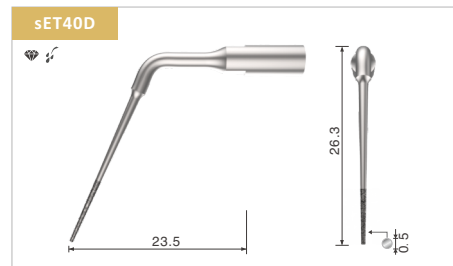

Diamond. A diamond-coated steel tip for retreatment of very hard material in the middle third. Length 40mm, 30 µm diamonds, taper 4%.

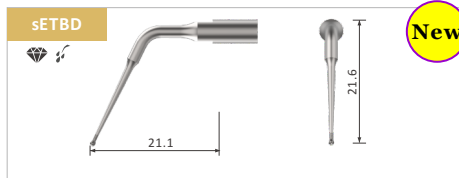

New

Calcification Locator. Used for searching for canals and locating calcified canals, diamond coated ball, length 20mm, taper 5%.

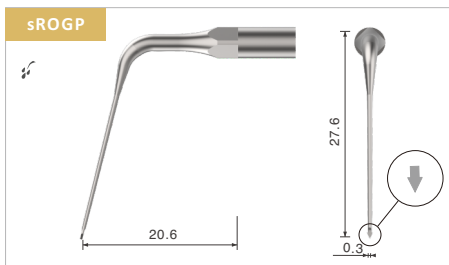

Access Long Canals. The ROGP tip is used to access areas not reached by other tips. Particularly effective for retreatments, especially in long oval canals, where most other tips would not fit. Excellent for Gutta-Percha removal.

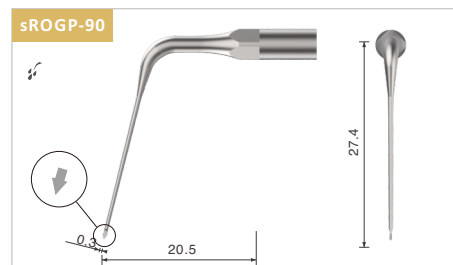

Access Long Canals - 90°. The ROGP tip is used to access areas not reached by other tips. Particularly effective for retreatments, especially in long oval canals, where most other tips would not fit. Excellent for Gutta-Percha removal.

RETRO

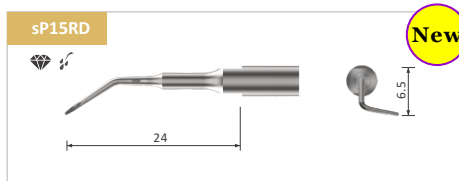

New

Retro Surgery Tip - Right. Used for preparation of premolars and molar canals, length 5mm, 30 µm diamonds, taper 7%.

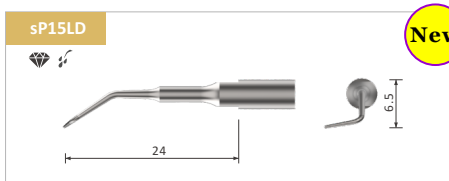

New

Retro Surgery Tip - Left. Used for preparation of premolars and molar canals, length 5mm, 30 µm diamonds, taper 7%.

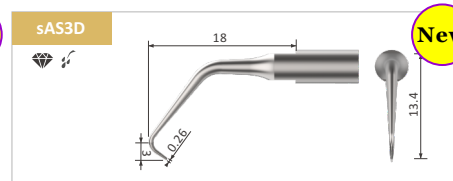

New

Universal Retro Surgery Tip. Used with minimum power and low pressure for apical surgery of anterior teeth, length 3mm, 30 µm diamonds, taper 9%.

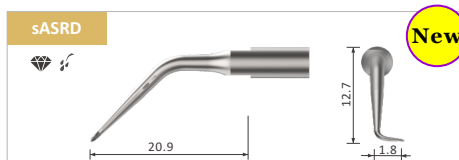

New

Retro Surgery Tip - Right. Used with low pressure for apical surgery of molars and premolars, length 3mm, 30 µm diamonds, taper 10%.

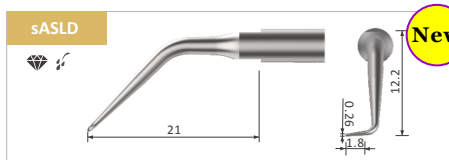

New

Retro Surgery Tip - Left. Used with low pressure for apical surgery of molars and premolars, length 3mm, 30 µm diamonds, taper 10%.

CONDENSATION

sC20 SET



New

Condensation. For cementing ceramic inlays, onlays and veneers. The sC20 SET contains 1 sC20 and 2 C20peeks.

C20peek



10X

New

Replacement. C20peeks are autoclavable and reusable.

IMPLANT CLEANING

sICP SET



Implant Cleaning. The ICP tip is used for sub- and supragingival cleaning of implants and restorations. The replaceable peek makes the action safe and gentle. The set contains 1 ICP, 1 ICP wrench and 2 spare peeks.

ICPpeek



10X

Replacement. ICPpeeks are autoclavable and reusable. Replacing the ICPpeek is simple using the wrench included in ICP SET.

TW UNI P



Universal

Plastic Torque Wrench



Xpedent tips (suitable for use with NSK® scaler machines).
The Xpedent brand belongs to a third party which has no connection with the original equipment manufacturer or its representatives.

Xpedent tips suitable for use with VARIOS®

SCALING

nG1

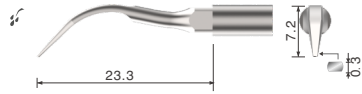

Universal. Removal of supragingival and marginal calculus, removal of calculus from narrow interdental regions.

nG4

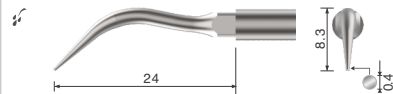

Scaling. Removal of supragingival and marginal calculus.

nG6

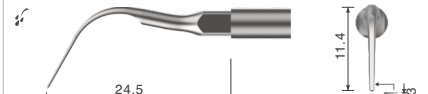

Slim. Removal of supragingival and marginal gingival calculus and removal of calculus from interproximal spaces.

nG8

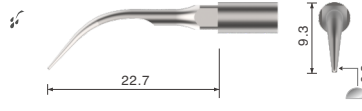

Universal Slim. Removal of supra and marginal gingival calculus; particularly effective in interdental spaces.

nG16

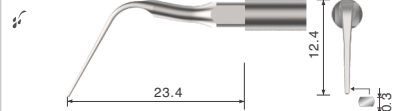

Interproximal. Removal of calculus from interproximal areas.

CONDENSATION

nC20 SET



New

Condensation. For cementing ceramic inlays, onlays and veneers. The nC20 SET contains 1 nC20 and 2 C20peeks.

C20peek



New

Replacement. C20peeks are autoclavable and reusable.

IMPLANT CLEANING

nICP SET



Implant Cleaning. The ICP tip is used for sub- and supragingival cleaning of implants and restorations. The replaceable peek makes the action safe and gentle. The set contains 1 ICP, 1 ICP wrench and 2 spare peeks.

ICPpeek



Replacement. ICPpeeks are autoclavable and reusable. Replacing the ICPpeek is simple using the wrench included in ICP SET.

TW UNI P



Universal
Plastic Torque Wrench

Xpedent tips suitable for use with TI-MAX®

SCALING

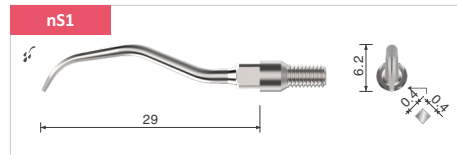

nS1
Universal. Removal of marginal gingival and supragingival calculus.

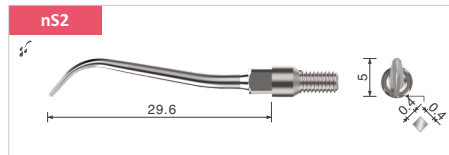

nS2
Perio. Removal of supragingival calculus.

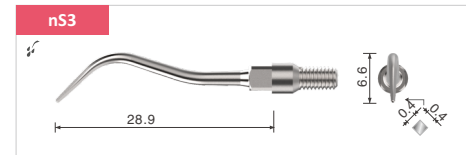

nS3
Sickle. Removal of supragingival calculus.

PERIO

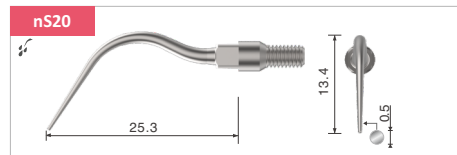

nS20
Root Planing. Long straight tip for the removal of subgingival calculus and biofilm.

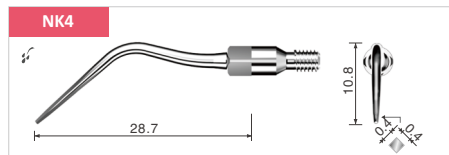

NK4
Universal slim tip.

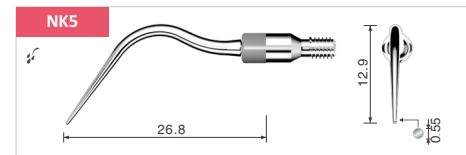

NK5
A root cleaning tip, straight application.

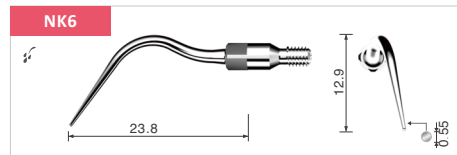

A root cleaning tip, with a left curve.

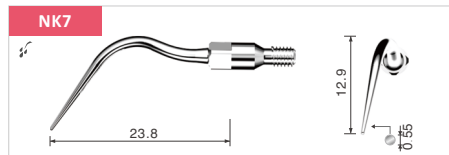

A root cleaning tip, with a right curve.

IMPLANT CLEANING



nSICP SET
Implant Cleaning. The ICP tip is used for sub- and supragingival cleaning of implants and restorations. The replaceable peek makes the action safe and gentle. The set contains 1 ICP, 1 ICP wrench and 2 spare peeks.



ICPpeek
Replacement. ICPpeeks are autoclavable and reusable. Replacing the ICPpeek is simple using the wrench included in ICP SET.

TW UNI P



Universal
Plastic Torque Wrench



Xpedent tips (suitable for use with SIRONA® scaler machines).
The Xpedent brand belongs to a third party which has no connection with the original equipment manufacturer or its representatives.

SCALING

sr1L

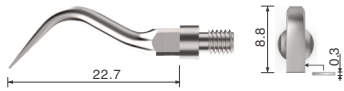

General. A flat tipped instrument for initial lingual and buccal scaling.

sr2L

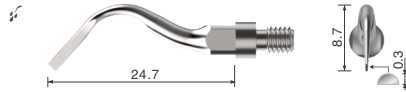

Versatile. A versatile instrument used for lingual, buccal and approximal scaling.

sr3L

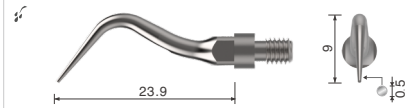

Interdental. A universal instrument which can be used for subgingival scaling at interdental sites.

sr4L

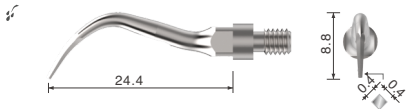

Universal. A fine instrument, ideal for supragingival and subgingival tooth surfaces and interdental areas.

PERIO

srPE1

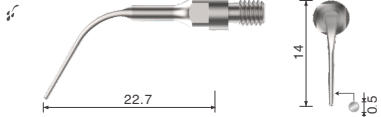

Perio. For rinsing and root cleaning in deep gum pockets.

srPE2

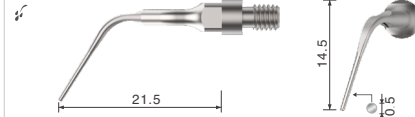

Perio. Curved to the right, for root cleaning in deep gum pockets in the posterior region.

srPE3

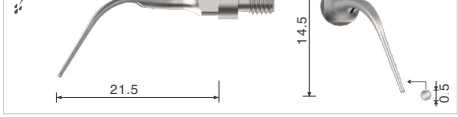

Perio. Curved to the left, for root cleaning in deep gum pockets in the posterior region.

IMPLANT CLEANING

srICP SET



Implant Cleaning. The ICP tip is used for sub- and supragingival cleaning of implants and restorations. The replaceable peek makes the action safe and gentle. The set contains 1 ICP, 1 ICP wrench and 2 spare peeks.

ICPpeek



Replacement. ICPpeeks are autoclavable and reusable. Replacing the ICPpeek is simple using the wrench included in ICP SET.

TW SIR P



Plastic Torque Wrench



Xpedent tips (suitable for use with KAVO® scaler machines).
The Xpedent brand belongs to a third party which has no connection with the original equipment manufacturer or its representatives.

Xpedent tips suitable for use with Sonicflex®

SCALING

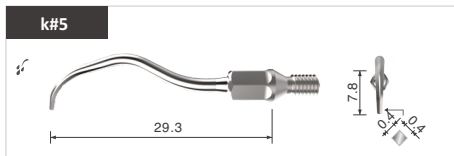

General. For calculus removal from all tooth surfaces.

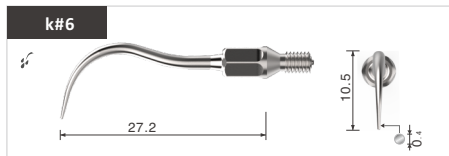

Fine. Fine instrument for smaller areas and those which are difficult to access.

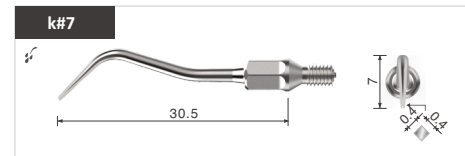

Subgingival. Instrument used for subgingival scaling.

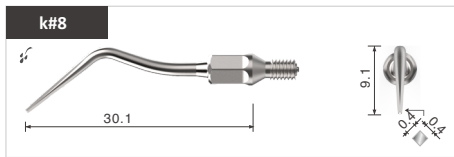

Subgingival. For the removal of subgingival calculus.

PERIO

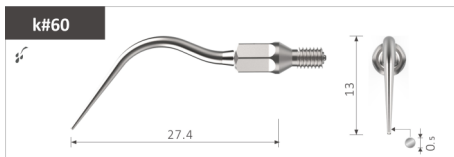

Perio. A long straight tip with rounded surfaces, the k#60 is used for gentle pocket cleaning during periodontal treatment. Used in the anterior region, it is effective on smooth surfaces and at cleaning pockets up to 9 mm deep.

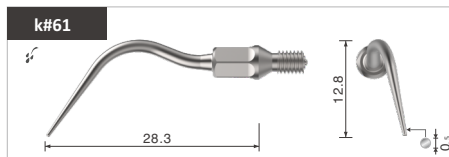

Perio Left. Curved to the left, for buccal access in the first and third quadrants to central incisor. Gentle but effective cleansing in pockets up to 9 mm deep, then cleansing of front teeth. Lingual access to premolars and molars in the second and fourth quadrants.

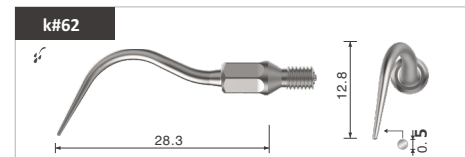

Perio Right. Curved to the right, for buccal access in the first and third quadrants to central incisor. Gentle but effective cleansing in pockets up to 9 mm deep, then cleansing of front teeth. Lingual access to premolars and molars in the second and fourth quadrants.

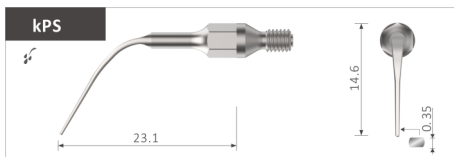

PerioSlim. The fast and minimally-invasive kPS instrument is ideal for calculus removal in deep periodontal pockets in all quadrants.

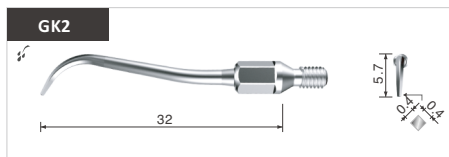

Used for supragingival, subgingival and interdental calculus removal.

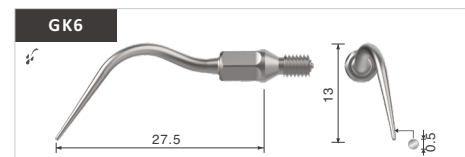

Curved to the left, used for supragingival, subgingival and interdental calculus removal.

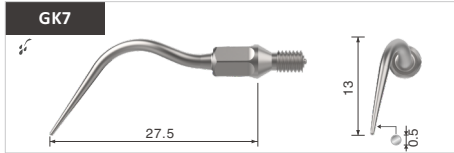

Curved to the right, used for supragingival, subgingival and interdental calculus removal.

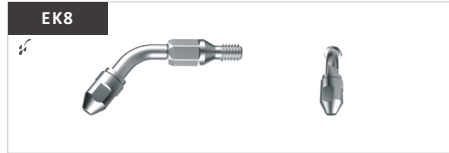

FG-bur Holder. FG-bur holder used to expand the root canal and grind teeth.

ENDO

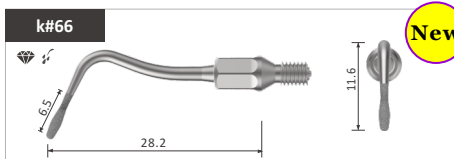

Access Shaping. Big bud shaped diamond coated tip for shaping the access cavity.

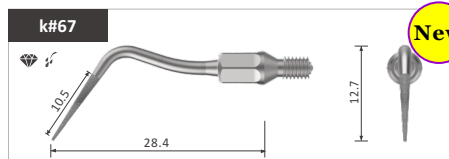

Canal Expansion. Diamond coated 125° conical tip. Used for widening canals.

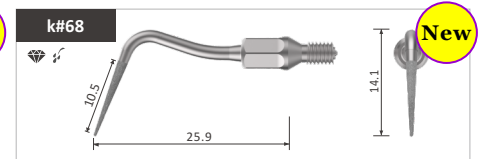

Canal Expansion. Diamond coated 112° conical tip. Used for widening canals.

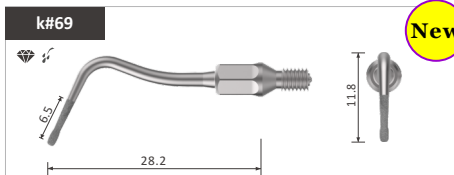

Canal Preparation. Small bud shaped diamond coated tip for removal of unwanted materials.

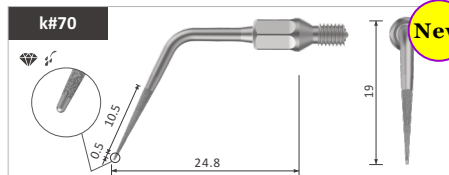

Long Canal Preparation. Long diamond coated 117° conical tip. Tip end not diamond coated for long and wide canals.

SURGERY

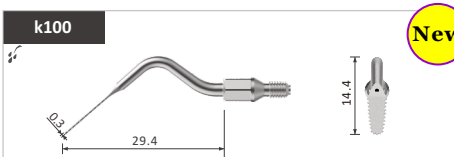

Minimally Invasive Surgery - Sagittal. Used for tooth detachment and extraction, fine bone cutting and splitting the alveolar crest. Easy to handle and gentle on soft tissues. Cutting depth of 10.7mm

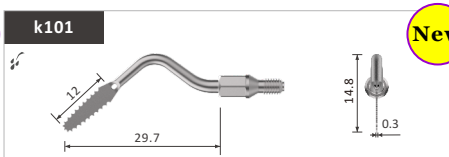

Minimally Invasive Surgery - Axial. Used for tooth detachment and extraction, fine bone cutting and splitting the alveolar crest. Easy to handle and gentle on soft tissues. Cutting depth of 10.7mm

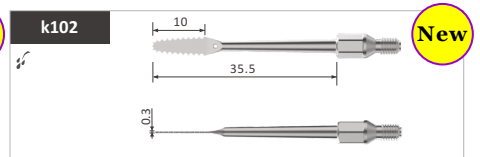

Minimally Invasive Surgery - Straight. Used for tooth detachment and extraction, fine bone cutting and splitting the alveolar crest. Easy to handle and gentle on soft tissues. Cutting depth of 10.7mm

IMPLANT CLEANING



Implant Cleaning. The ICP tip is used for sub- and supragingival cleaning of implants and restorations. The replaceable peek makes the action safe and gentle. The set contains 1 ICP, 1 ICP wrench and 2 spare peeks.



Replacement. ICPpeeks are autoclavable and reusable. Replacing the ICPpeek is simple using the wrench included in ICP SET.

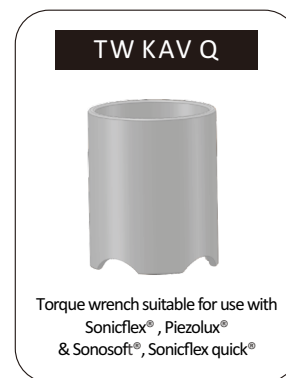

Xpedent tips suitable for use with Sonicflex quick®

SCALING

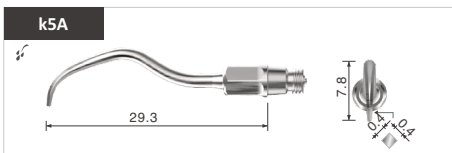

General. For calculus removal from all tooth surfaces.

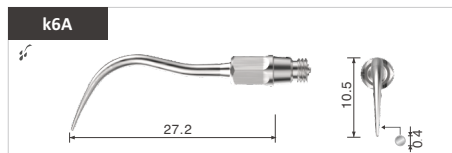

Fine. Fine instrument for smaller areas and those which are difficult to access.

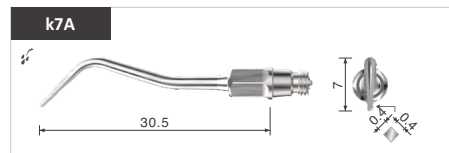

Subgingival. Instrument used for subgingival scaling.

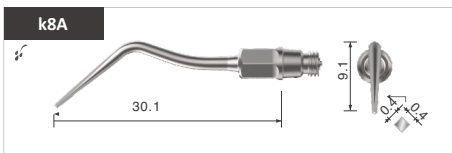

Subgingival. For the removal of subgingival calculus.

PERIO

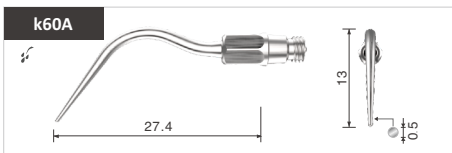

Perio. A long straight tip with rounded surfaces, the k60A is used for gentle pocket cleaning during periodontal treatment. Used in the anterior region, it is effective on smooth surfaces and at cleaning pockets up to 9 mm deep.

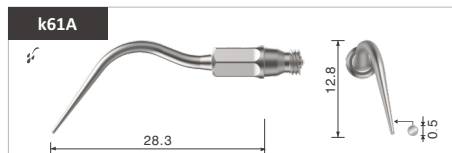

Perio LeftP. Curved to the left, for buccal access in the first and third quadrants to central incisor. Gentle but effective cleansing in pockets up to 9 mm deep, then cleansing of front teeth. Lingual access to premolars and molars in the second and fourth quadrants.

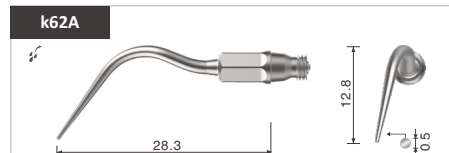

Perio Right. Curved to the right, for buccal access in the first and third quadrants to central incisor. Gentle but effective cleansing in pockets up to 9 mm deep, then cleansing of front teeth. Lingual access to premolars and molars in the second and fourth quadrants.

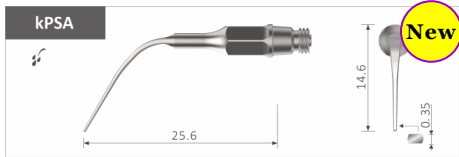

kPSA

PerioSlim. The fast and minimally-invasive kPSA instrument is ideal for calculus removal in deep periodontal pockets in all quadrants.

ENDO

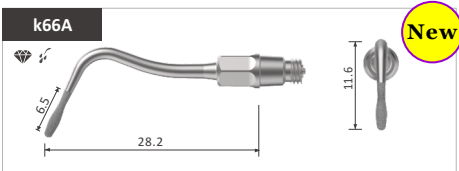

k66A

Access Shaping. Big bud shaped diamond coated tip for shaping the access cavity.

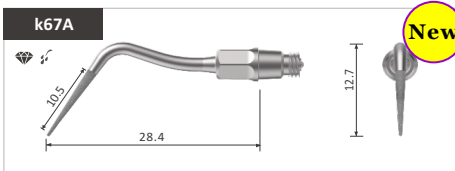

k67A

Canal Expansion. Diamond coated 125° conical tip. Used for widening canals.

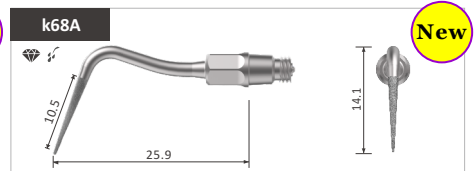

k68A

Canal Expansion. Diamond coated 112° conical tip. Used for widening canals.

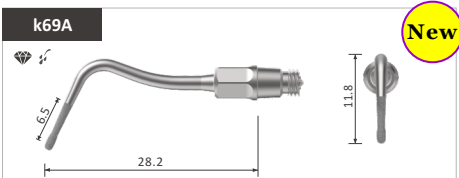

k69A

Canal Preparation. Small bud shaped diamond coated tip for removal of unwanted materials.

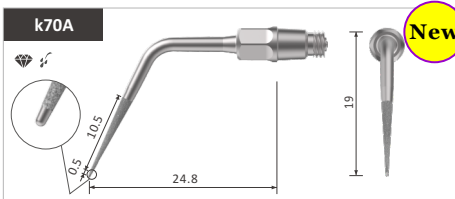

k70A

Long Canal Preparation. Long diamond coated 117° conical tip. Tip end not diamond coated for long and wide canals.

IMPLANT CLEANING



ICPA SET

Implant Cleaning. The ICP tip is used for sub- and supragingival cleaning of implants and restorations. The replaceable peek makes the action safe and gentle. The set contains 1 ICP, 1 ICP wrench and 2 spare peeks.



ICP peek

Replacement. ICPpeeks are autoclavable and reusable. Replacing the ICPpeek is simple using the wrench included in ICP SET.

TW KAV Q



Torque wrench suitable for use with
Sonicflex®, Piezolutux®
& Sonosoft®, Sonicflex quick®

Xpedit tips suitable for use with Piezolux® & Sonosoft®

SCALING & PERIO

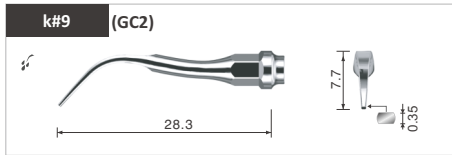

Sickle. Used to remove calculus and bacterial plaque from supragingival interdental calculus.

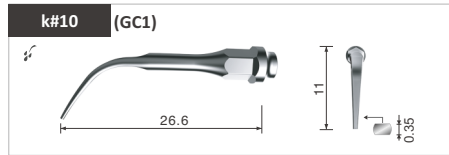

Perio. Used to remove calculus and bacterial plaque from supragingival interdental calculus.

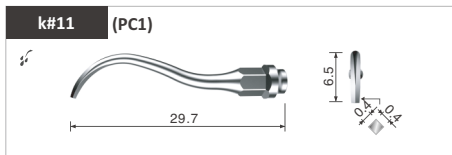

Universal. Used to remove subgingival calculus.

TW KAV Q



Torque wrench suitable for use with Sonicflex®, Piezolux® & Sonosoft®, Sonicflex quick®

Xpedit tips suitable for use with Piezoled® & Piezosoft®

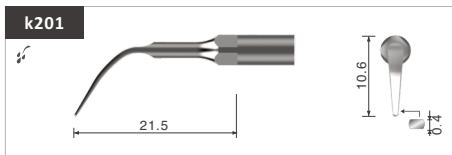

Universal. Accurate removal of solid supragingival calculus in all quadrants.

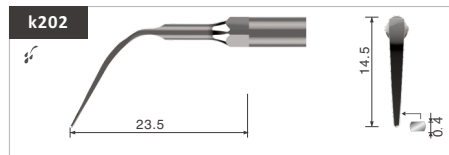

Perio. Well suited for the precise removal of stubborn subgingival and supragingival calculus and concretions in all quadrants.

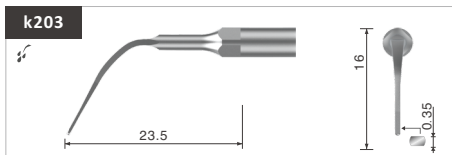

PerioSlim. Fast and minimally-invasive, ideal for calculus in deep periodontal pockets in all quadrants.



File Holder 120°. Use with Xpedit U files with a shank diameter of 0.57mm, this tip is usually used for anterior root canal cleaning.

TW KAV M



Torque wrench suitable for use with KAVO Piezoled® & Piezosofts®



Xpedent tips (suitable for use with AMDENT® scaler machines).
The Xpedent brand belongs to a third party which has no connection with the original equipment manufacturer or its representatives.

SCALING & PERIO

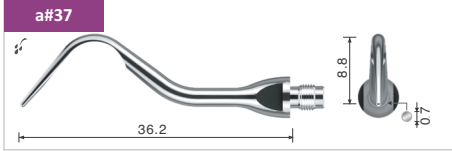

Universal. Tip for subgingival scaling, furcations, supragingival fine scaling and spot removal.

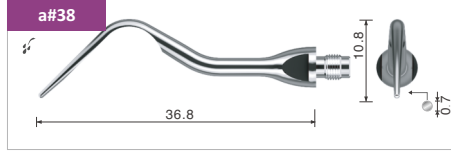

Perio. Primarily for lingual and buccal subgingival scaling and furcations. Also used for supragingival fine scaling and spot removal.

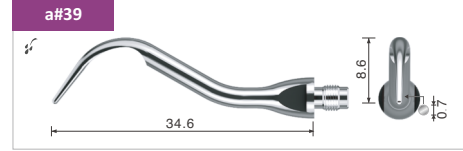

Heavy Calculus Removal. Can be used for lingual and buccal supragingival scaling.

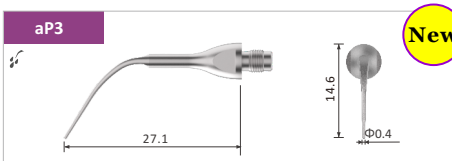

Perio. Used to remove subgingival calculus.

TW AMD M



Suitable for use with
Amdent® tips



Xpedent tips (suitable for use with MECTRON[®] surgery machines).
The Xpedent brand belongs to a third party which has no connection with the original equipment manufacturer or its representatives.

BONE CUTTING

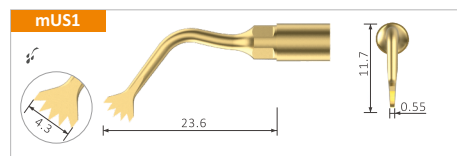

mUS1
Bone Saw. Osteotomy of large bone sections during maxillofacial surgery.

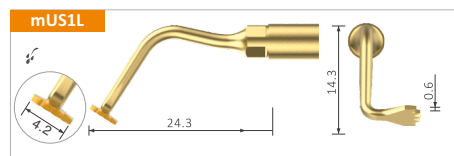

mUS1L
Angled Micro-Saw 0.6mm. All the osteotomy techniques in maxilla and mandible; bone block grafting, horizontal osteotomy - left angle.

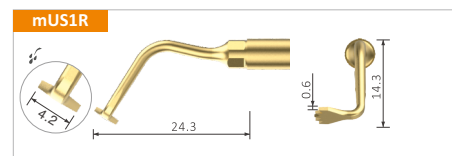

mUS1R
Angled Micro-Saw 0.6mm. All the osteotomy techniques in maxilla and mandible; bone block grafting, horizontal osteotomy - right angle.

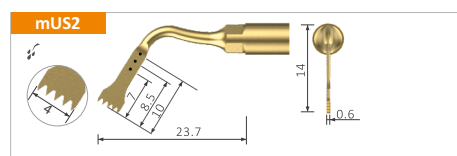

mUS2
Precision Saw. Used for cutting bone, with great precision and efficiency. Five sharp teeth.

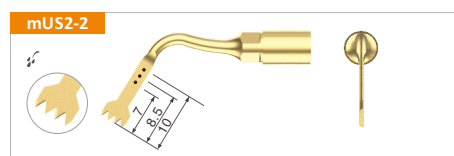

mUS2-2
Precision Saw. Used for cutting bone, with great precision and efficiency. Four sharp teeth.

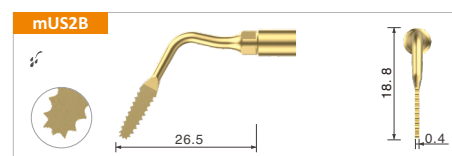

mUS2B
Saw Tooth. Used for cutting bone, with great precision and efficiency.

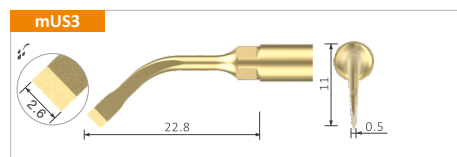

mUS3
Basic Scalpel. Osteotome of great precision in anatomically thin structures (for example ridge expansion, interdental corticotomies, nontraumatic nasal spina).

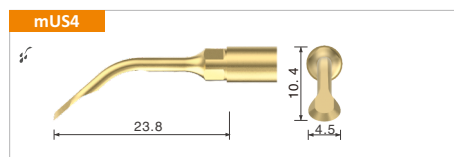

mUS4
Osteoplasty Scalpel. Universal osteoplasty, periodontal osteotomy, crown lengthening, bone chip harvesting, inflammatory tissue removal (cysts, etc.).

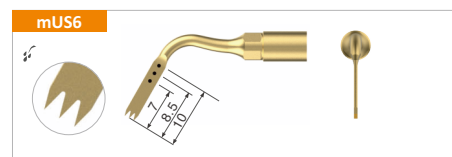

mUS6
Special Micro-Saw (3 teeth). Very thin and small osteotomy and corticotomy technique for orthodontic microsurgery, root fraction technique for dental extraction maneuver.

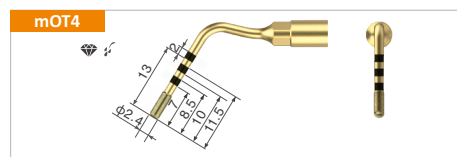

mOT4
Implant Site Preparation. To correct pilot osteotomy axis, to finalise the implant site preparation close to the alveolar nerve; sinus crestal approach techniques.

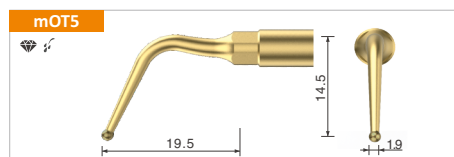

mOT5
Osteotomy & Osteoplasty. Osteotome of great precision in anatomically thin structures (for example ridge expansion, interdental corticotomies, nontraumatic nasal spina).

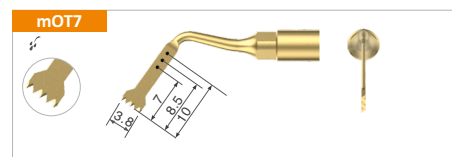

mOT7
Principal Micro-Saw 0.55mm. Osteotomy technique in maxilla and mandible, ridge expansion, corticotomy technique, and bone block grafting.

mOT7S-4

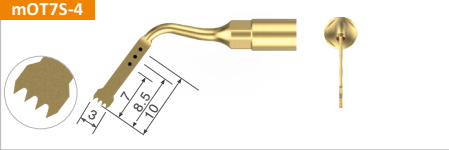

Special Micro-Saw 0.35 (4 Teeth). Very thin osteotomy, corticotomy for orthodontic microsurgery techniques, root separation in dental extraction techniques and periodontal surgery.

mOT7-20

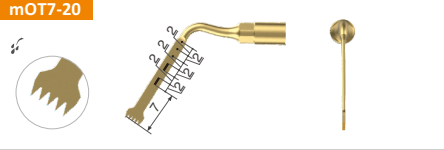

Efficient Osteotomy (5 Teeth). Ridge expansion, bone block grafting (from chin/mandible ramus), LeFort I osteotomy techniques, bilateral sagittal split osteotomy.

mOT12

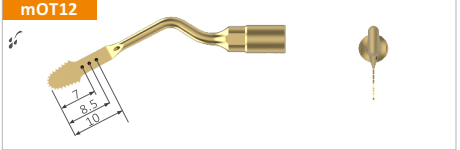

Precision Micro-Saw. Precise and efficient bone saw designed to enhance access for osteotomy in more difficult areas. Thickness : 0.25mm

mOP6



Micro-Root Preparation. Used for root preparation in periodontal surgery.

mOP7

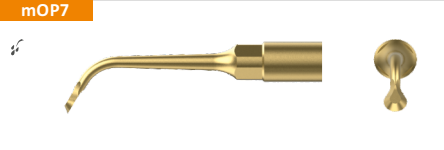

Micro-Osteoplasty. Used for peri-apical maxillary bone osteotomy access, the removal of inflammatory tissue.

SINUS LIFTING

mUL1

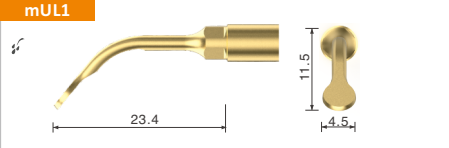

Sinus Membrane Separator Angled at 130°. Non-cutting separator of the sinus membrane.

mUL2

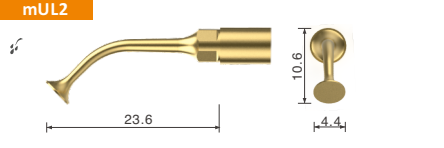

Sinus Membrane Separator. Separation of the sinus membrane, 2mm around the frame of the bony window.

mUL3

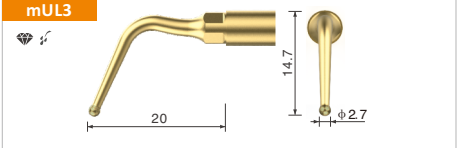

Sensitive Bone Cutting. Used for bone cutting near soft tissue or sensitive regions with minimal trauma. Ball end tip, diamond coated.

mUL4

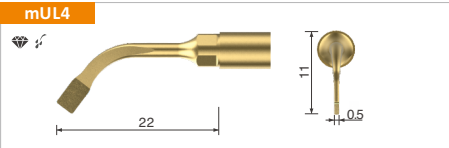

Sinus Bone Window Osteotomy. Periodontal osteotomy, crown lengthening, bone chip harvesting, inflammatory tissue removal (cysts, etc.).

mUL5

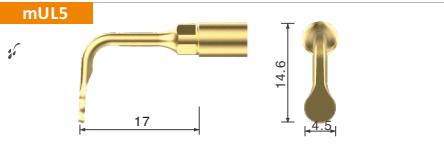

Sinus Membrane Separator Angled at 105°. Non-cutting separator of the sinus membrane.

IMPLANTATION

mUI1

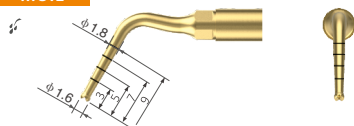

1.6 mm Enlargement. Used to enlarge implantation area avoiding soft tissue trauma.

mUI2

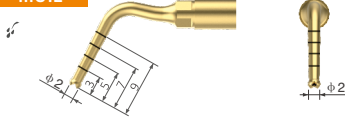

2.0 mm Enlargement. Used to enlarge implantation area avoiding soft tissue trauma.

mUI7

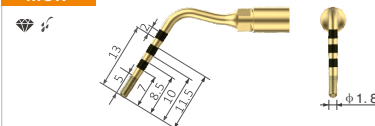

Fine Preparation. Used for final preparation of bone implant sites.

mUI8

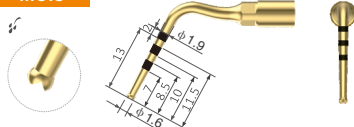

Implant Preparation. Diameter 1.6mm x 15mm. Used to enlarge implant site.

mUI9

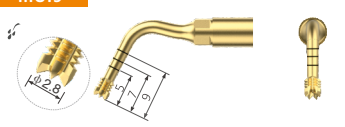

Implant Preparation. 2.8 mm Cutting head.

mUI9B



Deep Preparation. 2.8 mm Cutting head.

mIM1

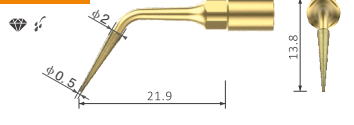

Diamond Bone Perforation. Conical surgery tip with diamond layer for bone perforation. Recommended for pilot osteotomy in extraction sites and to check the alignment of the axis of PIN IM1 preparations.

mIM2A

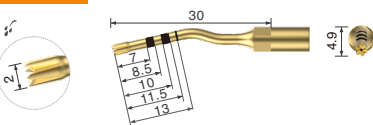

Bone Perforation. Preparation of the implant bed, especially bone perforation. Particularly effective for pilot osteotomy in the anterior and posterior (maxillary) region or to check the alignment of the axis of the preparations 2 PIN 2-2.4.

mIM2P

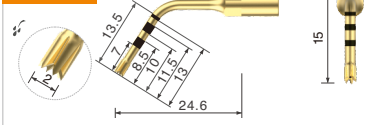

Bone Perforation. Pilot osteotomy in posterior region (in the maxilla).

mIM3A

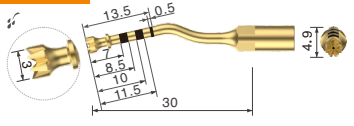

Bone Perforation. To enlarge or to finalise the implant site preparation; insert with double irrigation to avoid overheating (in the maxilla).

mIM3P

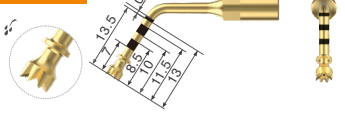

Bone Perforation. To enlarge or to finalise the implant site preparation; insert with double irrigation to avoid overheating (in the maxilla).

mIM4A

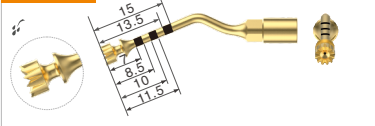

Bone Perforation. To finalise the implant site preparation; insert with double irrigation to avoid overheating (in the maxilla).

mIM4P

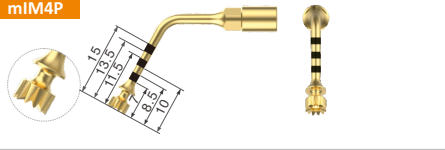

Bone Perforation. To finalise the implant site preparation; insert with double irrigation to avoid overheating (in the maxilla).

mIP2-3

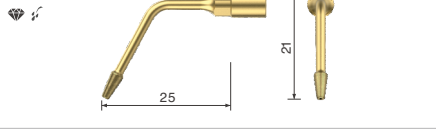

Pilot Implant Site Preparation. To optimise concentricity of implant site preparation between $\varnothing 2$ and $\varnothing 3$ mm.

mIP3-4

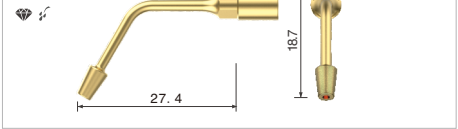

Micrometric Osteotomy. To optimise concentricity of implant site preparation between $\varnothing 3$ and $\varnothing 4$ mm.

RETRO

mUE1

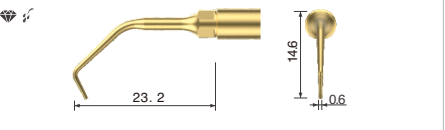

Efficient Canal Cleaning. Apical root debridement.

mUE2

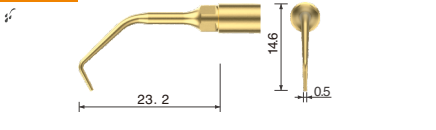

Gentle Canal Cleaning. Gentle apical root debridement.

mUE3

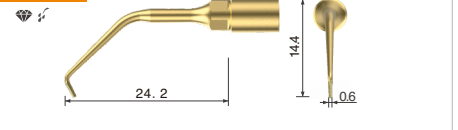

Efficient Canal Cleaning. Apical root debridement.

mUE4

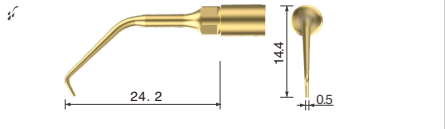

Gentle Canal Cleaning. Gentle apical root debridement.

EXTRACTION

mEX1

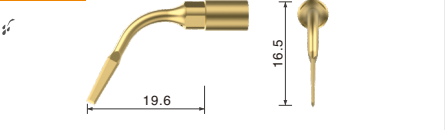

Extraction Scalpel. Root osteoplasty to cut off the ankylosis, root fraction techniques.

mEX2

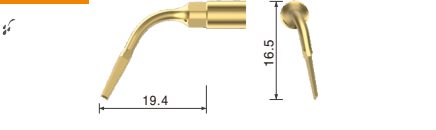

Angled Extraction Scalpel. Root osteoplasty in the posterior regions.

mEX3

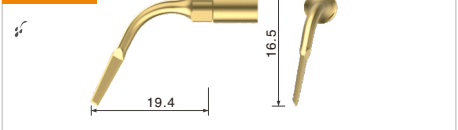

Angled Micro-Saw 0.6mm. Root osteoplasty in the posterior regions.

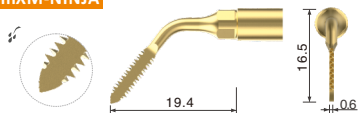
mXM-NINJA

Tooth Sectioning. Saw-tooth tip particularly efficient for hemisections and root amputations.

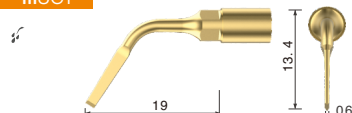
mUC1

Extraction Scalpel. Root osteoplasty to cut off the ankylosis, root fraction techniques.

SCALING

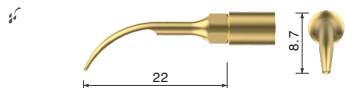
mUP1

Gentle Scaling. Root scaling.

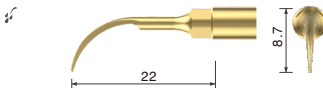
mUP2

Periodontal Scaler. Scaling and inflammatory tissue removal, fractured root apex extraction.

mUP3

Angled Curette. Angled curette root scaling.

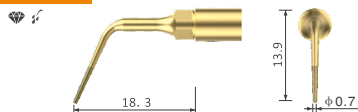
mUP4

Scaling and Microdebridement. Root debridement and root planing during resective and regenerative periodontal surgery.

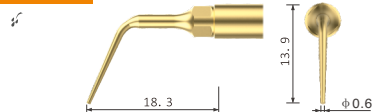
mUP5

Root Surface Micro-Smoothing. Root planing.

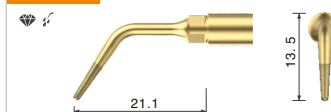
mUP6

Micro-Root Preparation. Root preparation in periodontal surgery.

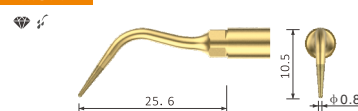
mUP7

Micro-Osteoplasty. Interproximal osteoplasty and root planing.

IMPLANT CLEANING

mICP SET



Implant Cleaning. The ICP tip is used for sub- and supragingival cleaning of implants and restorations. The replaceable peek makes the action safe and gentle. The set contains 1 ICP, 1 ICP wrench and 2 spare peeks.

ICPpeek



Replacement. ICPpeeks are autoclavable and reusable. Replacing the ICPpeek is simple using the wrench included in ICP SET.

TW MEC M

New



Suitable for use
with Mectron® tips



Xpedent tips (suitable for use with EMS[®] surgery machines).

The Xpedent brand belongs to a third party which has no connection with the original equipment manufacturer or its representatives.

Xpedent tips (suitable for use with SATELEC[®] surgery machines).

The Xpedent brand belongs to a third party which has no connection with the original equipment manufacturer or its representatives.

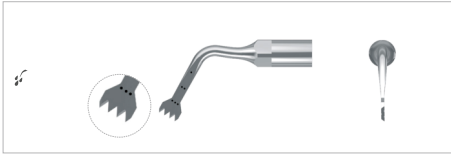
BONE SURGERY

Cortical Bone Saw. Saw intended for cutting of cortical bone in surgical orthodontics, pre-implant surgery, and bone distraction.

E-BS1

BS1

V-BS1

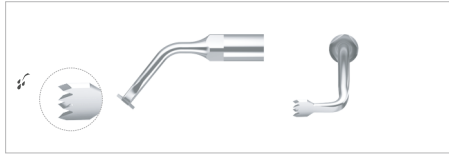

Left Cortical Bone Saw. Left-oriented bone saw used for cutting the ramus cortical bone.

E-BS2L

BS2L

V-BS2L

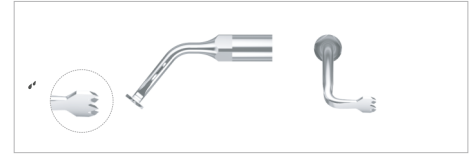

Right Cortical Bone Saw. Right-oriented bone saw used for cutting the ramus cortical bone.

E-BS2R

BS2R

V-BS2R



Circular Scalpel. Circular scalpel at 130° for osteoplasty and harvesting of bone particles or chips.

E-BS4

BS4

V-BS4



Flat Scalpel. For fine osteotomies. All high-precision osteotomy techniques such as crest expansion, osteotomy line, distraction, approach of the vestibular bone flap in the presence of a thick cortex in sinus surgery.

E-BS5

BS5

V-BS5

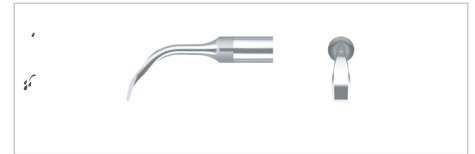

Curved Scalpel. Effective for substantial osseous reshaping. It is used to perform osteoplasties and reshaping of the bone not assuring the tooth support. It can also be used to mark a prosthetic reference point on enamel, where osteoplasty will begin.

E-BS6

BS6

V-BS6



Special Micro-Saw. Osteotomy technique in maxilla and mandible, ridge expansion, corticotomy technique and bone block grafting.

E-BS6F

IMPLANTATION



Diamond Bone Perforation. Conical surgery tip with diamond layer for bone perforation. Recommended for pilot osteotomy in extraction sites and to check the alignment of the axis of PIN IM1 preparations.

XS-IM1

V-IM1

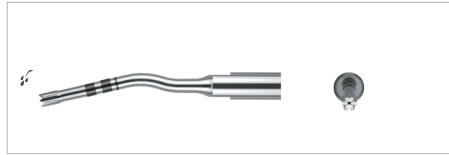

Bone Perforation. Preparation of the implant bed, especially bone perforation. Particularly effective for pilot osteotomy in the anterior and posterior (maxillary) region or to check the alignment of the axis of the preparations 2 PIN 2-2.4.

XS-IM2A

V-IM2A



Bone Perforation. To enlarge or to finalise the implant site preparation; insert with double irrigation to avoid overheating (in the maxilla).

XS-IM3A

V-IM3A

SINUS LIFTING



Sinus Bone Window Osteotomy. Diamond-coated tip for vestibular bone window cut and attenuation of sharp angles.

E-SL1

SL1

V-SL1



Micrometric Osteoplasty. Diamond-coated ball tip for smoothing the vestibular bone window and precise osteoplasty.

E-SL2

SL2

V-SL2

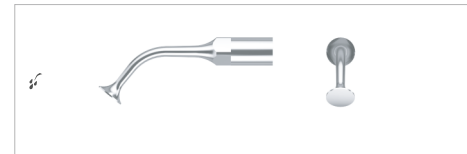

Sinus Membrane Separator. Non-cutting tip served for schneiderian membrane elevation on the window's edges.

E-SL3

SL3

V-SL3



Sinus Membrane Elevator. Non-cutting 90° angled spatula allows the sinus membrane to be lifted deep inside the sinus. Diameter of the spatula: 4mm

E-SL4

SL4

V-SL4



Non-Cutting Spatula. Non-cutting spatula used for schneiderian membrane elevation inside the sinus and for disengagement of anatomical structures.

E-SL5

SL5

V-SL5

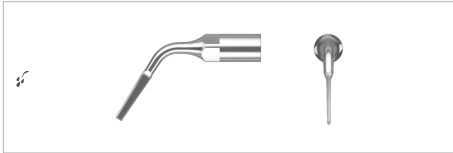
EXTRACTION

Root Osteoplasty. Used for syndesmotomy and periradicular osteotomy.

E-LC1

LC1

V-LC1



Extraction Scalpel. Used for cutting ligaments with minimal trauma when pulling out firm and solid teeth.

E-LC1/90

LC1/90

V-LC1/90

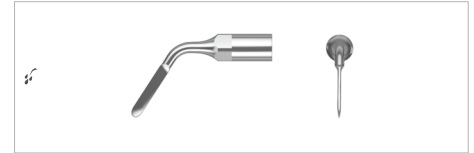

Slim Scalpel. Slim tip, particularly slim, allows for access to the tight spaces between the root and the alveolar bone.

E-LC2

LC2

V-LC2



Angled Scalpel. Left-oriented at 45°, tip facilitates access to the posterior areas.

E-LC2L

LC2L

V-LC2L



Angled Scalpel. Right-oriented at 45°, tip facilitates access to the posterior areas.

E-LC2R

LC2R

V-LC2R

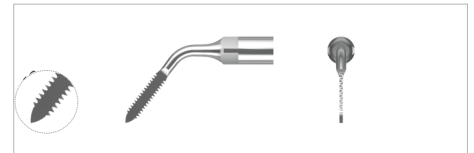

Root Amputator. Saw-tooth tip particularly efficient for hemisections and root amputations.

E-Pirahna

Pirahna

V-Pirahna

XPEDENT TORQUE WRENCHES & WRENCHES

TW UNI P



Universal
Plastic Torque Wrench for use
with EMS®, SATELEC®
and NSK® scaler tips

TW SIR P



Plastic Torque Wrench
suitable for use
with SIRONA® tips

TW KAV Q



Metal torque wrench suitable
for use with Kavo
Sonicflex®,
Piezolux® & Sonosoft®
and Sonicflex quick®

TW KAV M



Metal torque wrench suitable
for use with Kavo
Piezoled® & Piezosoft®

TW MEC M



Metal torque wrench suitable
for use with
all surgical Mectron® tips

TW AMD M

New



Metal torque wrench suitable
for use with
all Amdent® tips

W ENDO



Endo Wrench

ICP WREN



ICP Wrench

KICP WREN

New



ICP Wrench

SIRONA® is a registered trade mark of Sirona Dental Systems GmbH

EMS® is a registered trade mark of Electro Medical Systems SA

SATELEC® is a registered trade mark of ACTEON Group

Mectron® is a registered trade mark of Mectron s.p.a.

Amdent® is a registered trade mark of LM Instruments Oy

Kavo® is a registered trade mark of KAVO Dental Corporation

NSK® is a registered trade mark of Nakanishi INC. Corporation

Sonicflex®, Piezolux® & Sonosoft®, Piezoled® & Piezosoft®, Sonicflex quick® are registered trade marks of the company KAVO DENTAL GMBH

U-FILES (32mm)

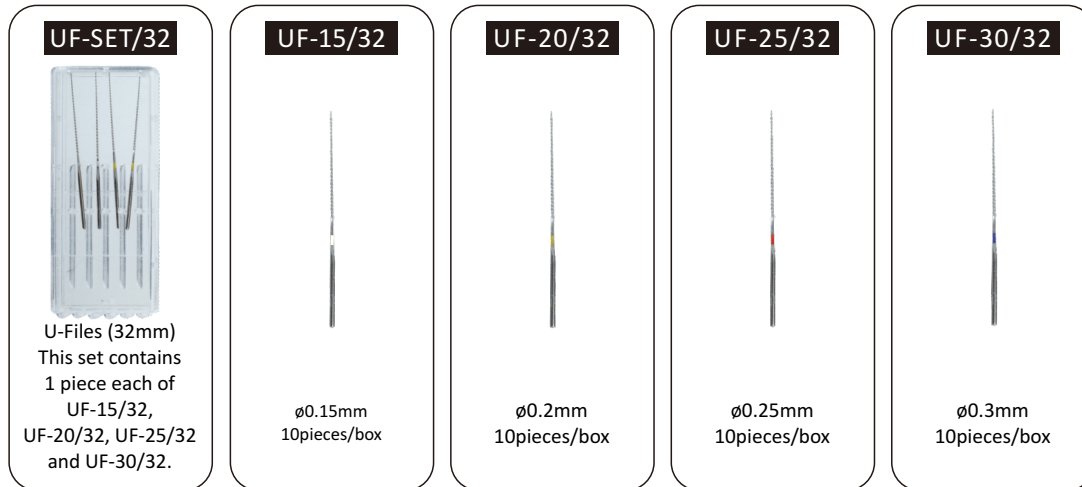

Attention: Our U-Files work with the following file holders:
E1, ES1, EN1, ED1, E2, ES2, EN2, ED2 and k222.

THREAD IDENTIFICATION

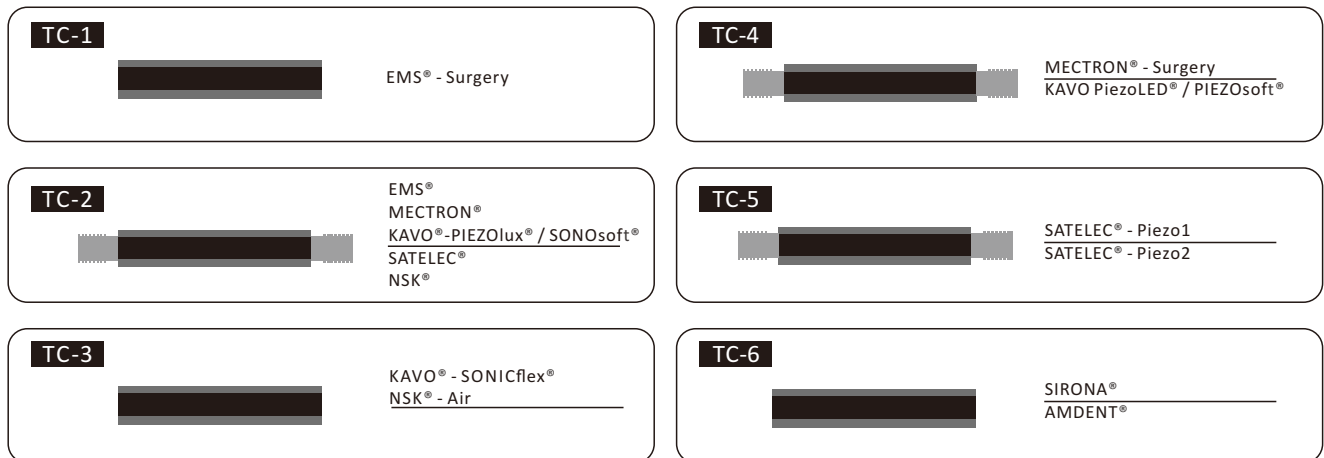

SIRONA® is a registered trade mark of Sirona Dental Systems GmbH
 EMS® is a registered trade mark of Electro Medical Systems SA
 SATELEC® is a registered trade mark of ACTEON Group
 Mectron® is a registered trade mark of Mectron s.p.a.
 Amdent® is a registered trade mark of LM Instruments Oy
 Kavo® is a registered trade mark of KAVO Dental Corporation
 NSK® is a registered trade mark of Nakanishi INC. Corporation
 Sonicflex®, Piezolux® & Sonosoft®, Piezoled® & Piezosoft®, Sonicflex quick® are registered trade marks of the company KAVO DENTAL GMBH

XPEDENT SCALER HANDPIECES

HP YE



NO-LED Handpiece suitable
for use with EMS® scaler machines

HP YS



NO-LED Handpiece suitable
for use with SATELEC® scaler machines

HP YE7 LED



LED Handpiece suitable
for use with EMS® scaler machines

HP YS8 LED



LED Handpiece suitable
for use with SATELEC® scaler machines

Xpedent handpieces are manufactured from aluminium, they are therefore able to withstand autoclaving without the exterior cracking problems often associated with plastic handpieces. They are suitable for use with EMS® and SATELEC® machines. LED handpieces have a different connection from non-LED.

AUTOCLAVABLE TIP HOLDERS

TH WC



Tip holder with cover

TH



Tip holder

ABOX purple

New

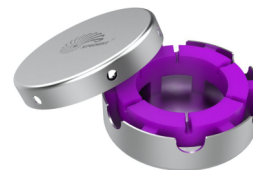

Tip holder with cover

XPEDENT BUILT-IN SCALER MACHINES



HP YE7 LED

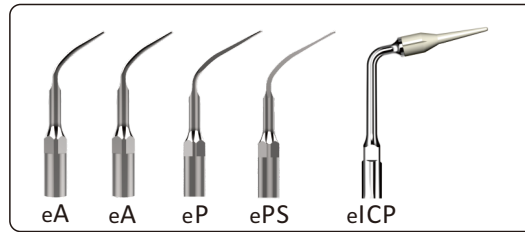

5 Tips

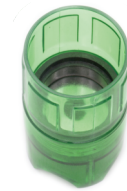

TW UNIP



SHEL-BE YE

SHEL-BE YS

Built-in Scaler: For installation into dental chair.

TIP WALLETS

DEMO1



DEMO1S



DEMO3



DEMO4



The tip wallets are made from black anodised aluminium. They are designed to show our tip range to best advantage. The standard wallets DEMO1 and DEMO1S contains our recommended range. Wallets can be customised for ODM or OEM use. They are recommended for both use at dental shows and by travelling sales staff.

Contact



- **Head Office - UK Sales**

Xpedent UK Ltd
The Old Granary
East Street
West Chiltington
West Sussex
RH20 2JY
England

uksales@xpedent.com
www.xpedent.com

VAT no: GB912844819

- **EU Sales & Marketing Office**

Xpedent Austria GmbH
Millennium Park 9
Ground Floor
6890 Lustenau
Austria

Tel. : +41 78 640 55 78
andreas@xpedent.com
www.xpedent.com
Contact: Mr. Andreas Riederer

VAT no: ATU75421447